



USER MANUAL

C5750Z-L4

WWW.YENTEK.EU



Disclaimer

Except for the accessories attached to the product as specified herein, what is contained in this user manual does not represent the commitments of Yentek Europe GmbH and reserves the right to revise this User Manual, without prior notice, and will not be held liable for any direct, indirect, intended or unintended losses and/or hidden dangers due to installation or improper operation.

Before ordering the products, please learn about the product performance from the distributors to see if it is in line with your needs. The ownership of other trademarks involved in this manual is owned by its respective owners.

The contents of this manual are protected by copyright law. All rights are strictly reserved. Any form of unauthorized reproduction including but not limited to carbon copy, facsimile transmission and electronic copy or email is prohibited.

For more information, please visit:

Website: <http://www.yentek.eu>

Support: info@yentek.eu

Order Information

No.	Model	Processor	Memory	MB	LAN	COM	HDMI	VGA	USB2.0	USB3.0	power
1	C5750Z-L4 V1.1(6650U)	i7-6650U/2.2G	2*SODDR4	C58_I726D	6*I210	2	1	1	3	4	DC 12V
2	C5750Z-L4 V1.1(6300U)	i5-6300U/2.4G	2*SODDR4	C58_I526D	6*I210	2	1	1	3	4	DC 12V
3	C5750Z-L4 V1.1(7200U)	i5-7200U/2.5G	2*SODDR4	C58_I526D	6*I210	2	1	1	3	4	DC 12V
4	C5750Z-L4 V1.1(7360U)	i5-7360U/2.3G	2*SODDR4	C58_I526D	6*I210	2	1	1	3	4	DC 12V
5	C5750Z-L4 V1.1(7500U)	i7-7500U/2.7G	2*SODDR4	C58_I726D	6*I210	2	1	1	3	4	DC 12V
6	C5750Z-L4 V1.1(8145U)	i3-8145U/2.1G	2*SODDR4	C81-I326D	6*I210	2	1	1	5	2	DC 12V
7	C5750Z-L4 V1.1(8265U)	i5-8265U/1.6G	2*SODDR4	C81-I526D	6*I210	2	1	1	5	2	DC 12V
8	C5750Z-L4 V1.1(8565U)	i7-8565U/1.8G	2*SODDR4	C81-I726D	6*I210	2	1	1	5	2	DC 12V
9	C5750Z-L4 V1.0(J6412)	J6412/2.0G	2*SODDR4	C641_J126D	2*I226	2	1	1	5	2	DC 12V
10	C5750Z-L4 V1.1(10210U)	i5-10210U/1.6G	2*SODDR4	C100_I526D	6*I210	2	1	1	5	2	DC 12V

Above order information just for reference, for more information please contact sales

Catalog

- Chapter 1 Product Introduction4
 - 1.1 Product Introduction4
 - 1.2 Dimension4
 - 1.3 Product Photo 5
- Chapter 2 Interface Definition 7
 - 2.1 Interface Graphics7
 - 2.2.1 Display 8
 - 2.2.2 LAN (LAN 1-6)..... 9
 - 2.2.3 Power Button / Reset Button / ACLOSS 9
 - 2.2.4 COM Port 9
 - 2.2.5 Phoenix Connector 10
- Chapter 3 BIOS Setting 12
 - 3.1. BIOS Description12
 - 3.2 BIOS Basic Function Setting12
 - 3.2.1 Enter into BIOS Interface 12
 - 3.2.2 Main Menu (BIOS information and time date) 13
 - 3.2.3 Advance14
 - 3.2.4 ACPI Settings 15
 - 3.2.5 Miscellaneous Configuration16
 - 3.2.6 Super IO Configuration 18
 - 3.2.7 PC Health Status 19
 - 3.2.8 CPU Configuration20
 - 3.2.9 CSM Configuration 21
 - 3.2.10 USB Configuration21
 - 3.2.11 Chipset22
 - 3.2.12 Boot24
 - 3.2.13 Security25
 - 3.2.14 Save&Exit 26
- Appendix27
 - Appendix one : Glossary of Terms27
 - Appendix Two: Common issue analysis and solution 29

Chapter 1 Product Introduction

1.1 Product Introduction

C5750Z-L4 is a high performance, fanless design industrial PC; 6* WGI211AT Gigabit LAN port, support Wake on LAN, PXE function; 1*HDMI, 1*VGA; 1* RJ45 CISCO RS232, 1* DB9 RS485/RS232 COM; support 1*12PIN Phoenix connector, 4-in 4-out GPIO, power button, 5V.

1.2 Dimension

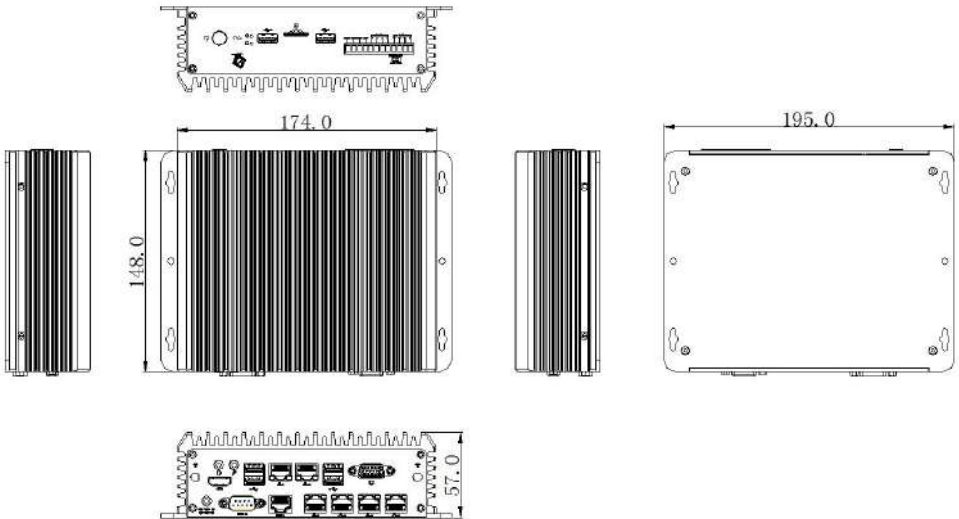

1.3 Product Photo



Image 1: C5750Z-L4 front IO



Image 2: C5750Z-L4 Rear IO

1.4 Specification

Model No.	C5750Z-L4 V1.1	
Chassis	Material/Struct	Full aluminum case, fanless design
	Color	Black
	Dimension	174mm*148mm*57mm
	Net Weight	1.35KG
	Installation	Desktop/Embedded
Front Panel I/O	POWER	1*Power button, 1*Reset button, 1*AC LOSS (auto power ON/OFF)
	LED	1*Power LED, 1*HDD LED
	USB	2*USB2.0, 1*Internal USB2.0
	SIM	1*SIM slot
	Phoenix	1*12P (include 4-in 4-out GPIO/Power/5V/GND)
Rear Panel I/O	Display	1*VGA, 1*HDMI1.4
	LAN	6*RJ45 Gigabit LAN port 卡
	USB	4*USB (USB2.0/3.0)
	COM	1*RS232/RS485 DB9 COM port, 1*RJ45 COM port
	Audio	1*Line out, 1* MIC
	Audio	1*12V DC_In Jack
Storage	SATA	1*2.5" SATA port
	MSATA	1*MSATA
Expansion	MINIPCIE	1*Mini PCIE, support 4G/WiFi
Power Supply	Power Type	External power adapter
	Voltage Input	DC 12V
	Consumption	AC TO DC, 60W
Environment	Operating	-10°C ~ 50°C
	Storage Temp.	-20°C ~ 70°C
	Relative	5%-95% relative humidity, non-condensing
	Working	0.5g rms/5-500HZ/random/operating

Chapter 2 Interface Definition

2.1 Interface Graphics

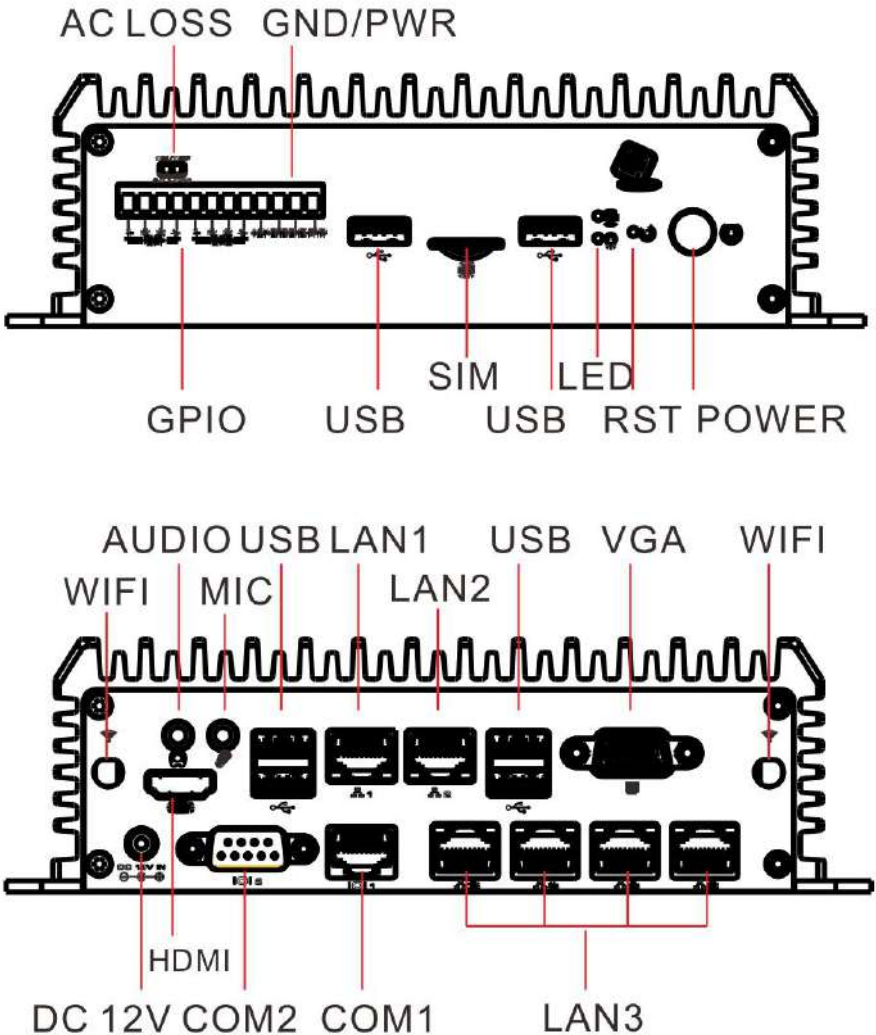

2.2 Interface Definition

2.2.1 Display

1*VGA, 1*HDMI dual independent display

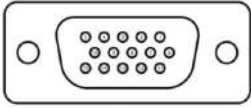

VGA Signal Definition

Pin	Signal Name	Pin	Signal Name
1	RED	2	GREEN
3	BLUE	4	ID2
5	GND	6	RGND
7	GGND	8	BGND
9	KEY	10	GND
11	ID0	11	ID1
13	HSYNC	14	VSYNC
15	ID3		

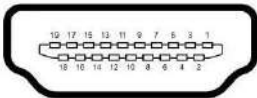

HDMI Signal Definition

Pin	Signal Name	Pin	Signal Name
1	TMDS Data2+	2	TMDS Data2 Shield
3	TMDS Data2-	4	TMDS Data1+
5	TMDS Data1 Shield	6	TMDS Data1-
7	TMDS Data0+	8	TMDS Data0 Shield
9	TMDS Data0-	10	TMDS Clock+
11	TMDS Clock Shield	12	TMDS Clock-
13	CEC	14	HRC Data-
15	SCL	16	SDA
17	GND	18	+5V
19	Hot Plug Detect		

2.2.2 LAN (LAN 1-6)

6*Intel I210AT Gigabit Ethernet

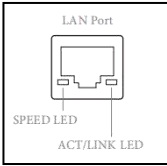

LAN LED Definition

Active/Link LED		SPEED LED	
State	Description	State	Description
Off	No Link	Off	10Mbps Connection
Blinking	Data Activity	Orange	100Mbps Connection
On	Link	Green	1Gbps Connection

2.2.3 Power Button / Reset Button / ACLOSS

1* Power button [PWR], 1*Reset button [RST], 1*Power LED [PWRLED],
1*HDDLED, 1*ACLOSS switch [ON/OFF] (electric auto power ON/OFF)

2.2.4 COM Port

C5750Z-L4 provide 2* RS232 COM port, include 1*RJ45 CISCO COM1, 1*DB9 COM2, COM2 RS232/RS485 selectable via jumper on C57-L4 expansion board.

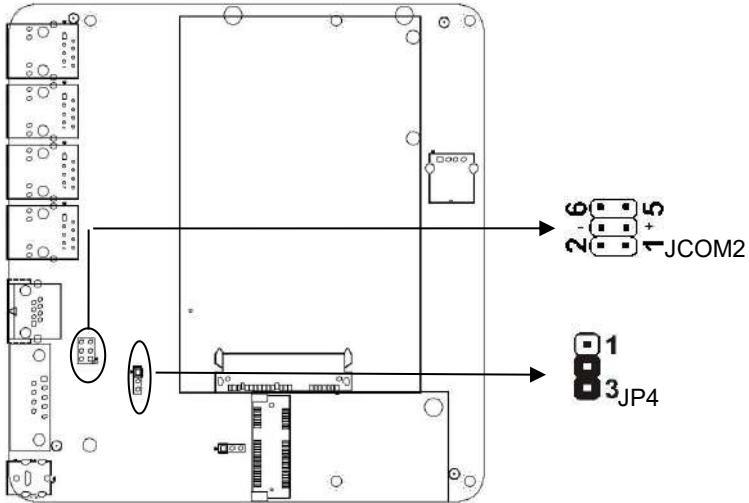

COM2 Definition

Pin	Signal Name	Pin	Signal Name
1	DCD	2	RXD
3	TXD	4	DTR
5	GND	6	DSR
7	RTS	8	CTS
9	RI	10	NC

COM2 RS485/232 Setting

Setting	JCOM2	Setting	JP4
Short connect 3-5 Short connect 4-6	RS485	Short connect 1-2	RS485
Short connect 1-3 Short connect 2-4	RS232	Short connect 2-3	RS232

2.2.5 Phoenix Connector

1*12pin Phoenix connector, include 4-in 4-out GPIO,+5V,GND.

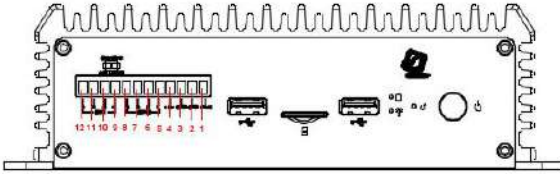

Phoenix Connector Definition

Pin	Signal Name	Pin	Signal Name
1	PWR	2	GND
3	GND	4	+5V
5	GPIO out	6	GPIO out
7	GPIO out	8	GPIO out
9	GPIO in	10	GPIO in
11	GPIO in	12	GPIO in

Tips:

Please use a dedicated power adapter. After confirming that the interface is connected correctly, press the POWER button on the front panel of the computer to turn on the device. How to identify the alarm sound: (a long beep is system memory error; a short beep" is boot sound).

Chapter 3 BIOS Setting

3.1. BIOS Description

BIOS (Basic Input and Output System) , via CMOS chip on motherboard, it recorded parameter settings of each hardware of the system. BIOS contains the BIOS setup program, for users to set system parameters according to their own needs, to make the motherboard work normal or execute specific function.

Through BIOS setup program to modify the settings (except date and time), which are stored in the flash memory of system, the power required to memorize CMOS data are supplied by the battery on board, so when the system power off, the data will not lost, when next time re-open the power, system will read the set data. If needed to restore factory setting at the circumstance when can not enter the Setup interface due to misconduct, please short circuit JBA12,3 pin to clear CMOS data.

Note! BIOS settings directly affect the performance of the computer, wrong set parameters will cause damage to the computer, or even can not boot, please use the BIOS built-in default values to restore the normal operation of the system.

Due to the company's different product, the interface will be slightly different, the flowing image for reference only, it may be not exactly the same with your current using BIOS setup program.

3.2 BIOS Basic Function Setting

3.2.1 Enter into BIOS Interface

Following below steps to enter into BIOS interface

- 1、 Power on, the display screen will appear POST interface.
- 2、 When the screen appears "click or<ESC> to enter setup", please click or <ESC>, and you can enter the BIOS setup program
- 3、 Move the arrow key < ↑ >< ↓ >< < >< > to the options which you want to modify, click <Enter>, and you can enter the sub-screen of the option
- 4、 Use the arrow keys and the <Enter> key to modify the value of the selected items, click the Enter key to select BIOS option and modify.
- 5、 Use the <ESC> key to return to the last picture
- 6、 <Page Up/+> Add numeric value or change

<Page Down/> Reduce numeric value or change

<F1> Set sub menu help

<F9> Set default values (optimize to factory settings)

<F10> Save BIOS settings

3.2.2 Main Menu (BIOS information and time date)

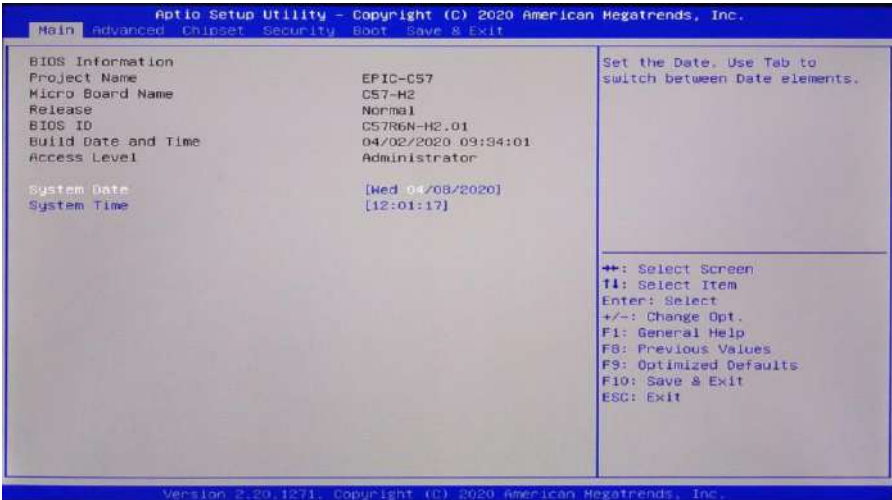

Bios ID :

Build Date and Time :

Access Level:

System language:

System Date :

Set the current date. In the form of month / day / year. The setting range is:

Month (Jan.-Dec.), Date(01-31), Year(Max to 2099), Week(Mon.~Sun.).

System Time :

Set the current time, In the form of time/minute/second, The setting range is:

Hour(00-23), Minute(00-59), Second(00-59).

3.2.3 Advance



ACPI Settings : Advanced configuration and power management interface settings.

IT8786 Super IO Configuration: contains COM port interrupt number and address settings

Hardware Monitor: system monitoring, hardware monitoring, hardware monitor

Miscellaneous Configuration : include timing start up, power on auto start-up, watchdog, etc.

CPU Configuration:

USB Configuration:

CSM Configuration:

3.2.4 ACPI Settings

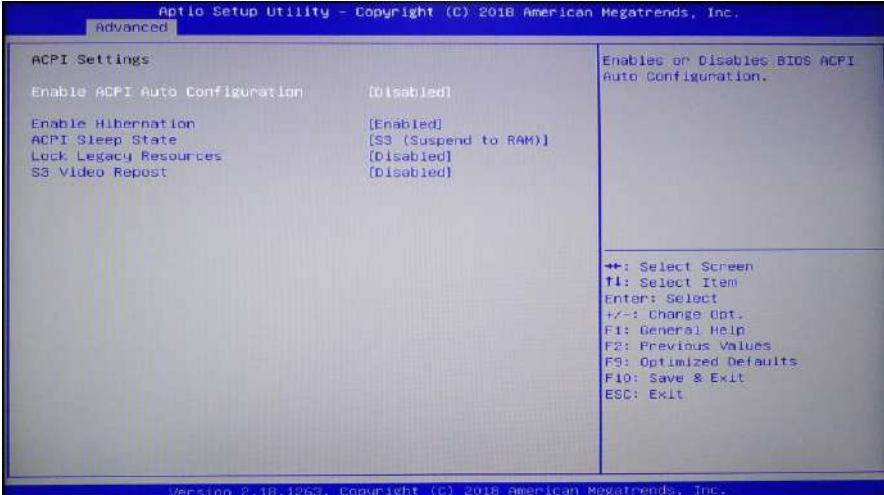

Enable ACPI Auto Configuration : This item is automatically configured for the ACPI, Allow (Enabled) or close (Disabled) BIOS ACPI automatic configuration, default is close (disabled).

Enable Hibernation : Enabled or Disabled system sleep function (OS/S4 sleep state). This option does not take effect under some OS. Default is Enabled.

ACPI Sleep State : This is used to select the system to enter the power system sleep mode, the pattern is not the same, the system power consumption is not the same degree, Suspend Disabled; close the sleep mode, S1(CPU Stop Clock): CPU stops working, other devices are still normal power supply; S3(Suspend to Ram): Hang up to memory.

Lock Legacy Resources : Resource latch, (Enabled) or (Disabled) resource latch function.

3.2.5 Miscellaneous Configuration

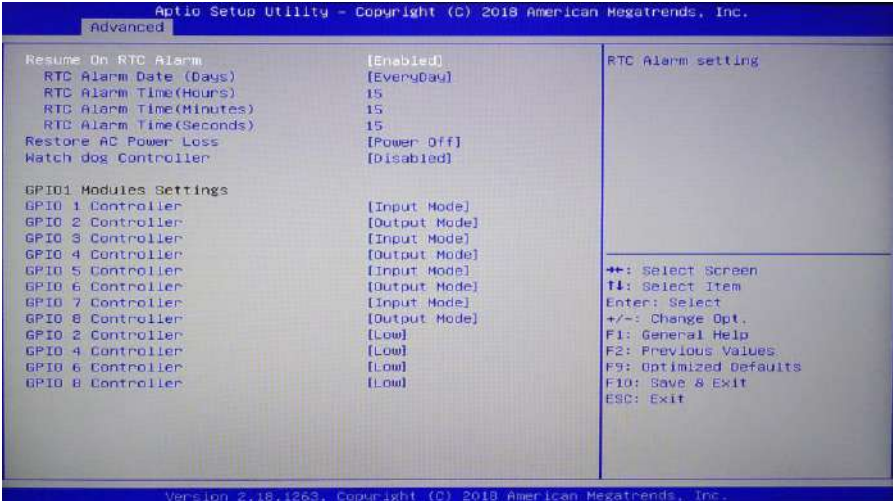

Resume On RTC Alarm :

RTC Alarm Date(Days):

RTC Alarm Time(Hours):

RTC Alarm Time(Minutes):

RTC Alarm Time(Seconds):



Restore AC Power Loss: this option is used to set the power on condition after connecting to electric. Power Off: need to press power button to power on; Power On: Power on directly after connecting to electric; Last State: keep previous state after connecting to electric.



Watch dog controller: [Disabled] disable watchdog, [Second mode] set the watchdog to seconds mode, [Minute Mode], set the watchdog to minute mode.

3.2.6 Super IO Configuration

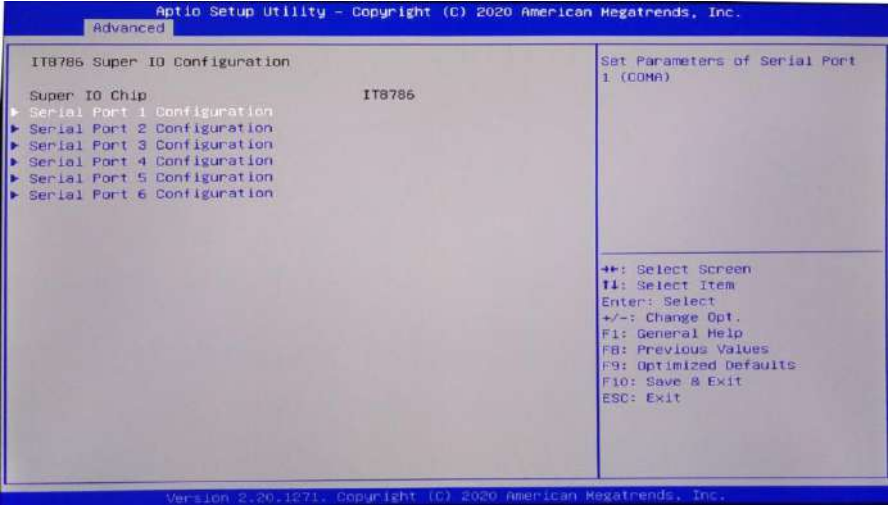

Serial Port 1 Configuration: Super IO configuration information, including COM port interrupt number and address setting.

Serial Port 2 Configuration:

Serial Port 2 Configuration:

Serial Port 3 Configuration:

Serial Port 4 Configuration:

Serial Port 5 Configuration:

Serial Port 6 Configuration:

3.2.7 PC Health Status

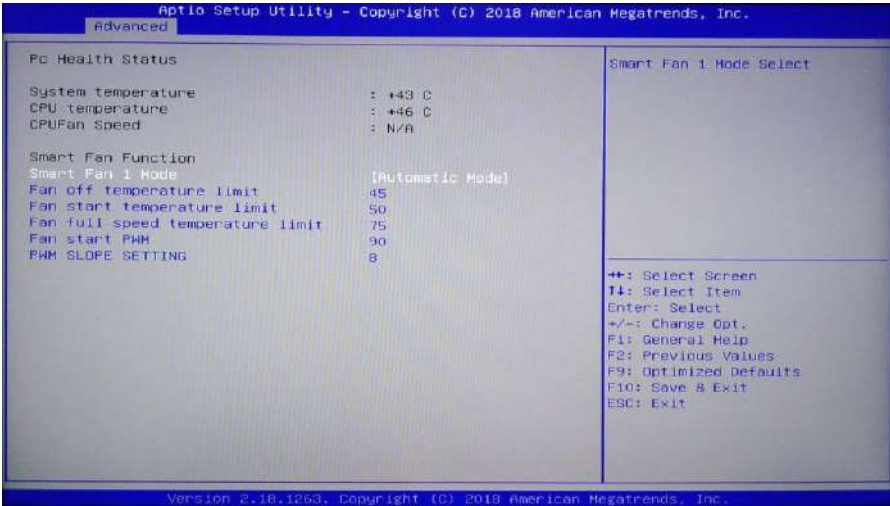

PC Health Status: shows the current system temperature, CPU temperature, fan speed, and other relevant voltage value. The above parameters have a certain range, system cannot operate beyond the scope.

Smart Fan 1 Mode: This option is whether or not open the CPU automatic fan control function, used to adjust CPU fan speed automatically according to the real-time detected CPU temperature, to achieve the purpose of saving energy.

Fan off temperature limit: Fan stop minimum temperature setting.

Fan start temperature limit: Fan start minimum temperature setting.

Fan start PWM: Fan start PWM value setting.

PWM slope setting:

3.2.8 CPU Configuration

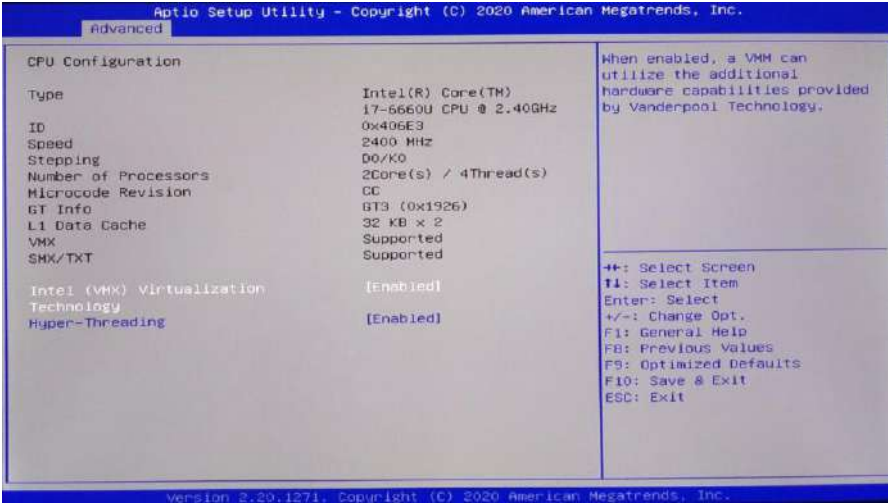

Read only items contain details of the CPU, including the CPU manufacturers, models, frequency, the first level cache size, the second level cache size and other information.

Intel Virtualization Technology :

Intel Virtualization Technology Is Intel's CPU in the system of virtual technology. It makes it possible to enable a PC running a plurality of OS, VT technology is in various types of processors, including dual core processor play very important role, this technique allows the processor with and / or virtualization technology, using Vanderpool technology, we can run two operating systems simultaneously on the same machine. In which a processor running an operating system, another processor running another operating system.

3.2.9 CSM Configuration

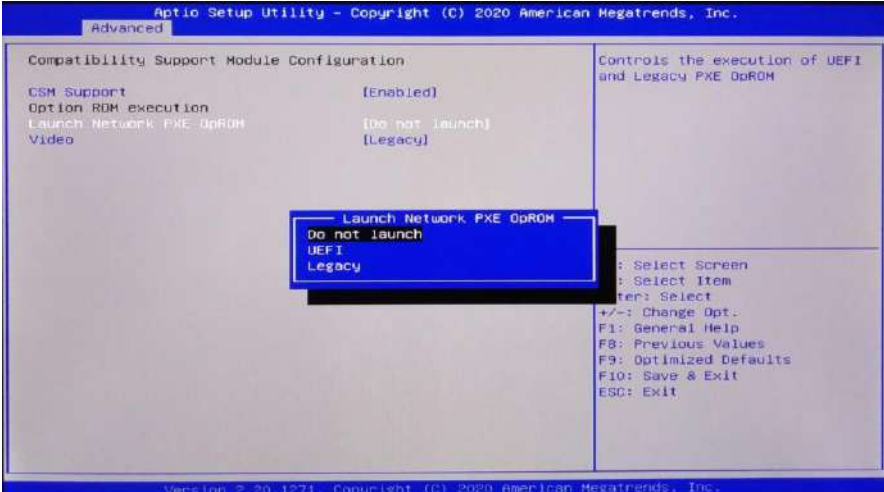

Launch Network PXE OpRom: set None-Disk boot; Do not launch: close None-disk boot; UEFI: set non-disk boot mode as UEFI; Legacy: set None-Disk boot as Legacy mode.

3.2.10 USB Configuration

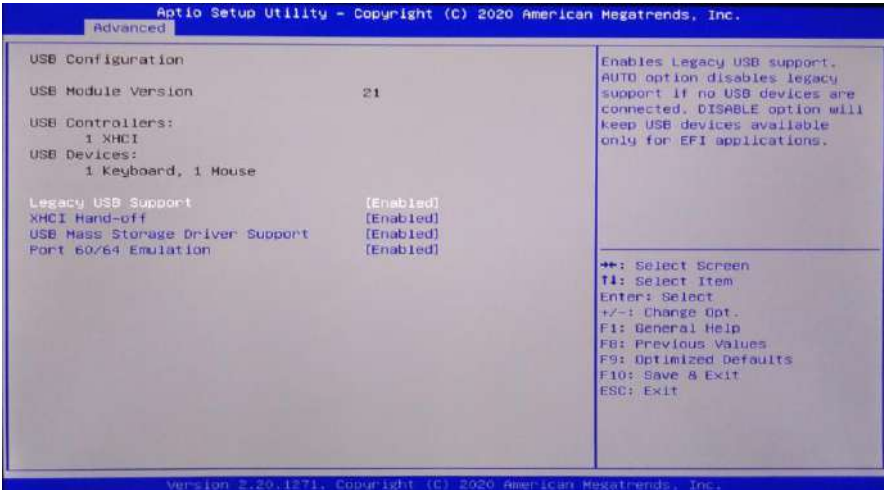

Legacy USB Support :

This is used for old version USB setting, if need to support USB devices in DOS,

such as U disk, USB keyboard, etc., choose the option [Enabled] or [Auto]. on the contrary, choose [Disabled].

XHCI Hand-off :

When operating system does not support XHCI, whether to allow BIOS to take over XHCI control

USB Mass Storage Driver Support :

3.2.11 Chipset

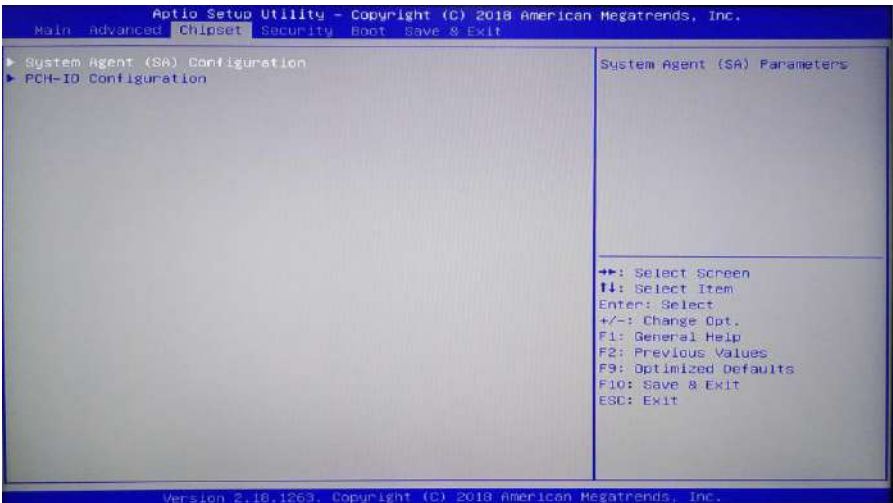

PCH-IO Configuration :

South bridge configuration option, include audio card, LAN card options, etc.

System Agent (SA) Configuration :

North bridge configuration options, include video memory, display device, LVDS, etc.



VT-d :

Intel's I/O virtualization technology, need chipset to support it, some chipset support, some don't. The BIOS will show or hide this option according to different chipset. Please enable it when installing virtual computer.

Memory Configuration:

Graphics Configuration:

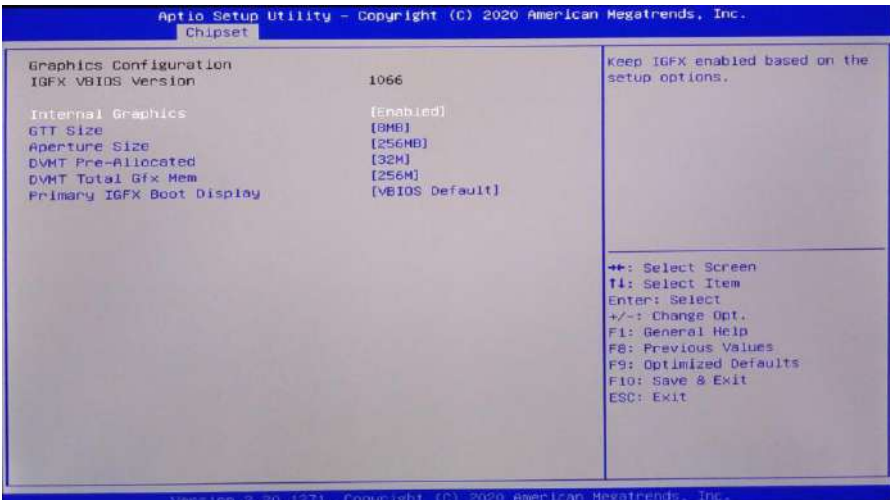

DVMT Pre-Allocated: Dynamically allocate the value of video memory.

DVMT Total Gfx Mem: Dynamically allocate the value of the total graphics card.

Aperture Size:

GTT Size:

Primary IGFX Boot Display : Vbios selection, Graphics boot configuration.

3.2.12 Boot



Setup Prompt Timeout: click the Setup shortcut key to wait time. If have not click the setup shortcut key in the setup time it will continue to boot.

Quiet Boot: (Disabled or, enabled) .

Fast Boot : (Disabled or, enabled) .

Boot Option Priorities : system will inspect device in accordance with the set procedure, until find a device that can be boot, and then boot from this device. Boot option #1 is the most preferred boot device.

3.2.13 Security



Password character length hint: the minimum length is 3, the maximum length is 20.

Administrator Password :

The option is used to set the super user password.

3.2.14 Save&Exit

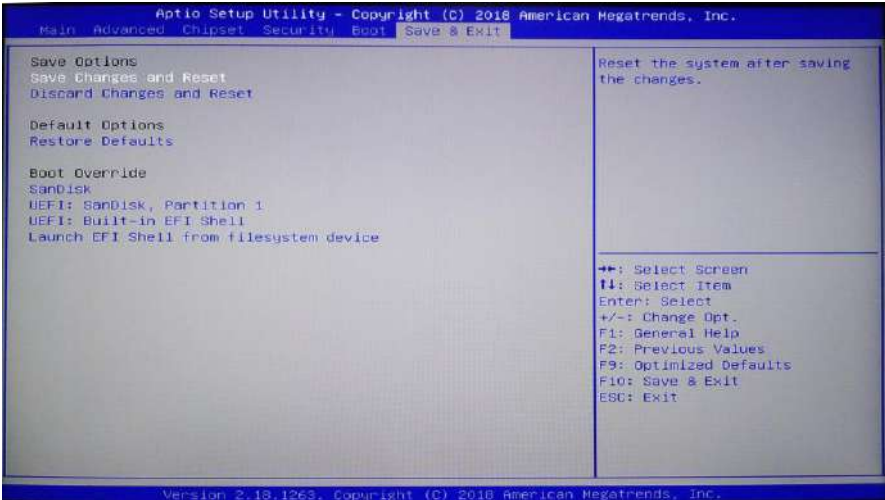

Save Changes and Reset : Save the BIOS settings, and exit the settings interface, continue to start the computer

Discard Changes and Reset : Discard changes and exit setup interface, restart the computer.

Restore Defaults: Load optimization settings, if choose this, the system will be set according to the factory's optimal value.

Boot Override : Select the specified Boot devices, such as SATA hard disk, U disk, Shell EFI, PXE and so on, direct Boot, do not save and exit, press F11 to select the specified device Boot.

Appendix

Appendix one : Glossary of Terms

ACPI

Advanced configuration and power management. The ACPI specification allows the operating system to control most of the power of the computer and its additional equipment.

BIOS

Basic input / output system. It's a software that contains all the input/output control code interface in PC. When the system starts, it carries out the hardware detection., began to the operation of the operating system, between the operating system and hardware to provide an interface. BIOS is stored in a read-only memory chip.

BUS

In a computer system, the exchange of data between the different parts of the channel, is a set of hardware lines. We refer to the BUS is usually CPU and main memory components within the local circuit.

Chipset

Chipset is designed to perform one or more functions integrated chip. We refer to is composed of South Bridge and North Bridge System on chip group, It determines the structure and main function of the motherboard.

CMOS

Complementary metal oxide semiconductor. Is a widely used semiconductor type. It has the characteristics of high-speed, low power consumption. We refer to CMOS is on the motherboard CMOS ram reserved space, used to save the date, time, system information and system parameter setting information.

COM

Serial port, a universal serial communication interface, generally use the standard DB9 common interface connection mode.

DIMM

Dual in-line memory module. A memory chip group of small circuit board. The memory bus width of 64bit.

DRAM

Dynamic random access memory. A normal computer general memory types. A transistor and a capacitor is usually used to store a single bit. With the development of technology, type and specification of DRAM has in computer application becomes

more and more diverse. For example, are now commonly used are: SDRAM, DDR SDRAM and RDRAM.

LAN

Local area network interface. A small region mutual association of computer is composed of a computer network is generally in a business unit or building. LAN is generally by the server, workstations, some communication links, a terminal can anywhere through the wire access to data and equipment. Many users can be expensive equipment and resource sharing.

LED

Light emitting diode, a semiconductor device, when the current flows through it will be lit, usually used to represent the information very intuitive, such as the power supply has been turned on or the hard drive is working.

PnP

Plug and play. Allows the PC external devices to be automatically configured, users can not manually operate the system can work on their own specifications. To achieve this feature, BIOS support PnP and a PnP expansion cards are required.

POST

During the start up system, BIOS will perform a continuous testing on the system, including the detection of RAM, keyboard, hard drives, etc., to see whether they are properly connected and whether the normal work.

PS/2

The IBM development of a keyboard and mouse interface specification. PS/2 is a DIN only 6PIN interface can also be used to connect to other devices such as a modem.

USB

Universal serial bus. A suitable for low-speed peripherals hardware interface, typically used to connect the keyboard, mouse, and so on. A PC up to 127 USB devices connected to provide a 12mbit / s transmission bandwidth; USB support hot swap and multiple data stream function, namely in the system can plug in a USB device, the system can automatically identify and allow the insertion of the device normal.

Appendix Two: Common issue analysis and solution

Common Faults	Check Points
No start up after connecting power	<ol style="list-style-type: none">1. Make sure the power cable is connected properly2. Please confirm all the power supply can meet the requirements of the motherboard3. Try to re-plug the memory4. Try to change the memory5. Try to clear the CMOS according to motherboard manual6. Please confirm whether there is an external card, remove the card and check again
VGA no display after power on	<ol style="list-style-type: none">1 To check whether the monitor is open2 Check whether the power cable is properly connected to the monitor and system unit3 Check whether the display cable is properly connected to the system unit and the display4 Check whether the display brightness control is set to the dark state, can improve brightness through the brightness control.5 Display in the "power save" mode, press any key on the keyboard
BIOS Setup can not be saved	<ol style="list-style-type: none">1. Please check whether the CMOS battery voltage is lower than 2.8V, if so, please replace a new battery, set again and save2. BIOS settings are not correct, according to the boot screen prompt button (DEL), adjust the time and date in the Setup BIOS
Prompt message	<ol style="list-style-type: none">1. Please check whether the hard drive power cord, data cable is

cannot find bootable device	<p>connected normally</p> <ol style="list-style-type: none">2. Please check whether the hard disk has physical damage3. Please check whether the operating system is normally installed on the hard disk
Blue screen or crash when enter into OS	<ol style="list-style-type: none">1. Please check whether the memory card and the card is loose2. Try to remove the newly installed hardware, uninstall the driver or software3. Try to replace the memory
Slow speed to enter into OS	<ol style="list-style-type: none">1. Try to use third party software to check whether the hard disk has bad sectors2. Please check whether the hard disk remaining space is too small for operating system.3. Please check whether the CPU cooling fan is rotating normally
System restart automatically	<ol style="list-style-type: none">1. Please check whether the CPU cooling fan is rotating normally2. Please check whether triggered reset button wrongly3. Please use anti-virus software to confirm whether the system is infected with the virus4. Please check whether the memory card and the card is loose5. Please confirm that the power capacity is sufficient, can try to replace the power supply
Can not detect USB device	<ol style="list-style-type: none">1. Please check whether the USB device needs separate power supply2. Please check whether the USB interface has bad contact3. Please check whether the USB controller is open in BIOS Setup